

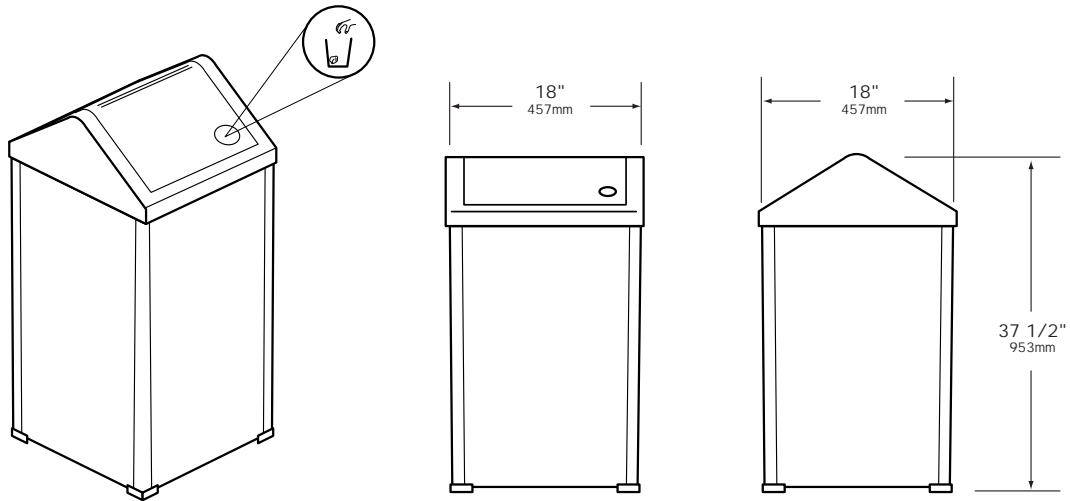

WR-13 Waste Receptacle



Construction:

Fabricated 18-8 type 304 heavy gauge stainless steel. All welded construction with exposed surfaces having a #4 satin finish. Top has self-closing doors. Vinyl wall bumper and rubber feet provided.

Capacity:

36 gallons

Overall Dimensions:

18" (457mm)W x 37-1/2" (953mm)H x 18" (457mm)D

Options:

Available without top - specify Suffix "NT".

Available with liners specify "VL"

Hooks for liners are optional

Manufacturer reserves the right to make changes in design or dimensions without formal notice.